

SIGNAGE PLAN

FORTUNE CASINO

Therefore, Staff's decision is that the proposed signs are not subject to a sign permit and shall be permitted. However, prior to obtaining a building permit, staff requests that the applicant:

1. Select a pole color for the freestanding sign that is more aligned with the building's architectural and design theme. **COMPLETED** POLES WILL MATCH OCHRE TRIM ON BUILDING
2. Correct the sign lighting for the smaller "wall" signs to be downward facing as required by LCMC 8.60.070(g). **COMPLETED** ALL LIGHTING IS FACING DOWNWARD ON ALL WALL SIGNS.
comply with the requirement that the proposed lighting does not exceed 10.0-footcandle over a property line. **COMPLETED** BAFFEL ADDED OVER TOPS OF LIGHTS & DIMMERS ADDED TO ALL LIGHTING

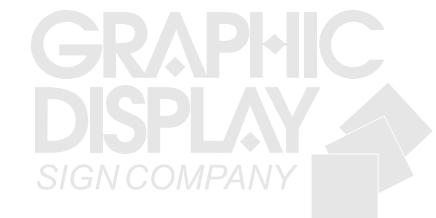

318 NW PACIFIC HIGHWAY, LA CENTER WA 98629

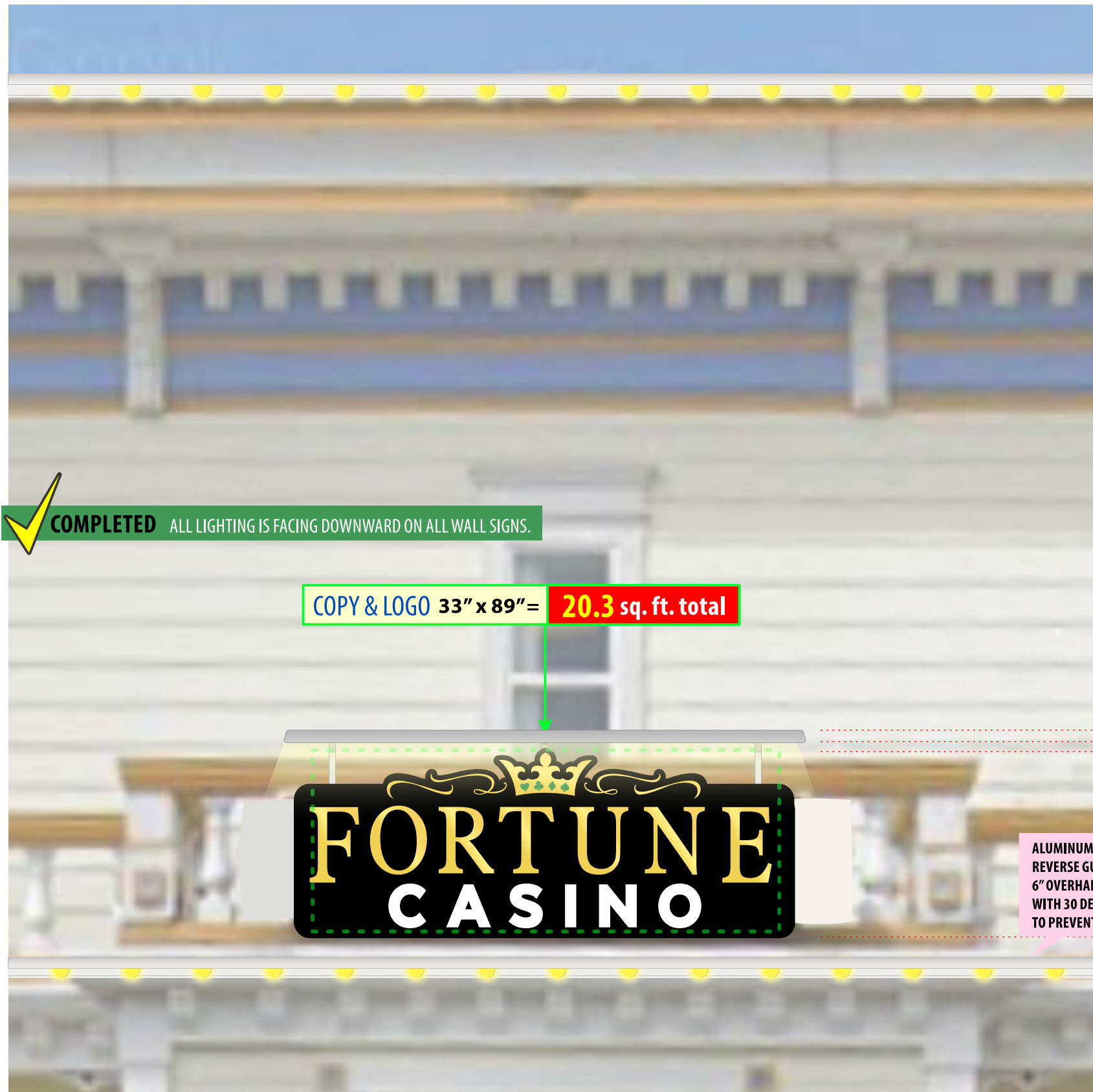

#1 YELLOW LED BORDER LIGHTING

COMPLETED BAFFEL ADDED OVER TOPS OF LIGHTS & DIMMERS ADDED TO ALL LIGHTING

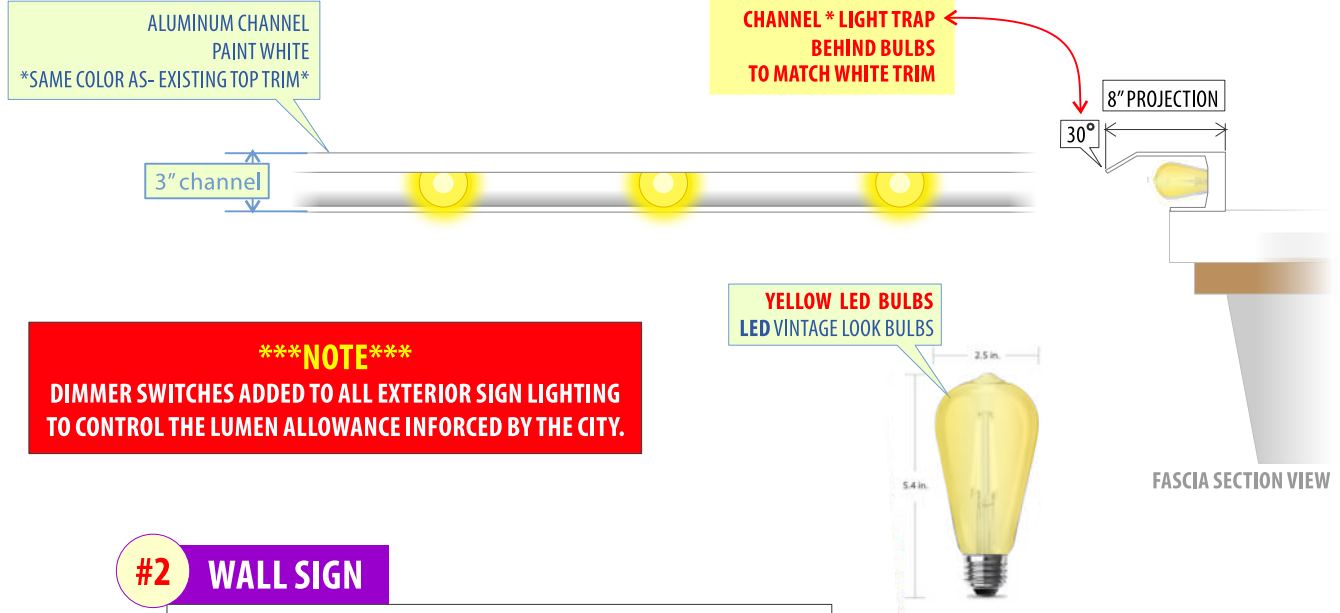

*****NOTE*****
DIMMER SWITCHES ADDED TO ALL EXTERIOR SIGN LIGHTING TO CONTROL THE LUMEN ALLOWANCE INFORCED BY THE CITY.

#2 WALL SIGN

FABRICATE & INSTALL ONE (1) SINGLE FACE EXTERNALLY ILLUMINATED WALL SIGN.

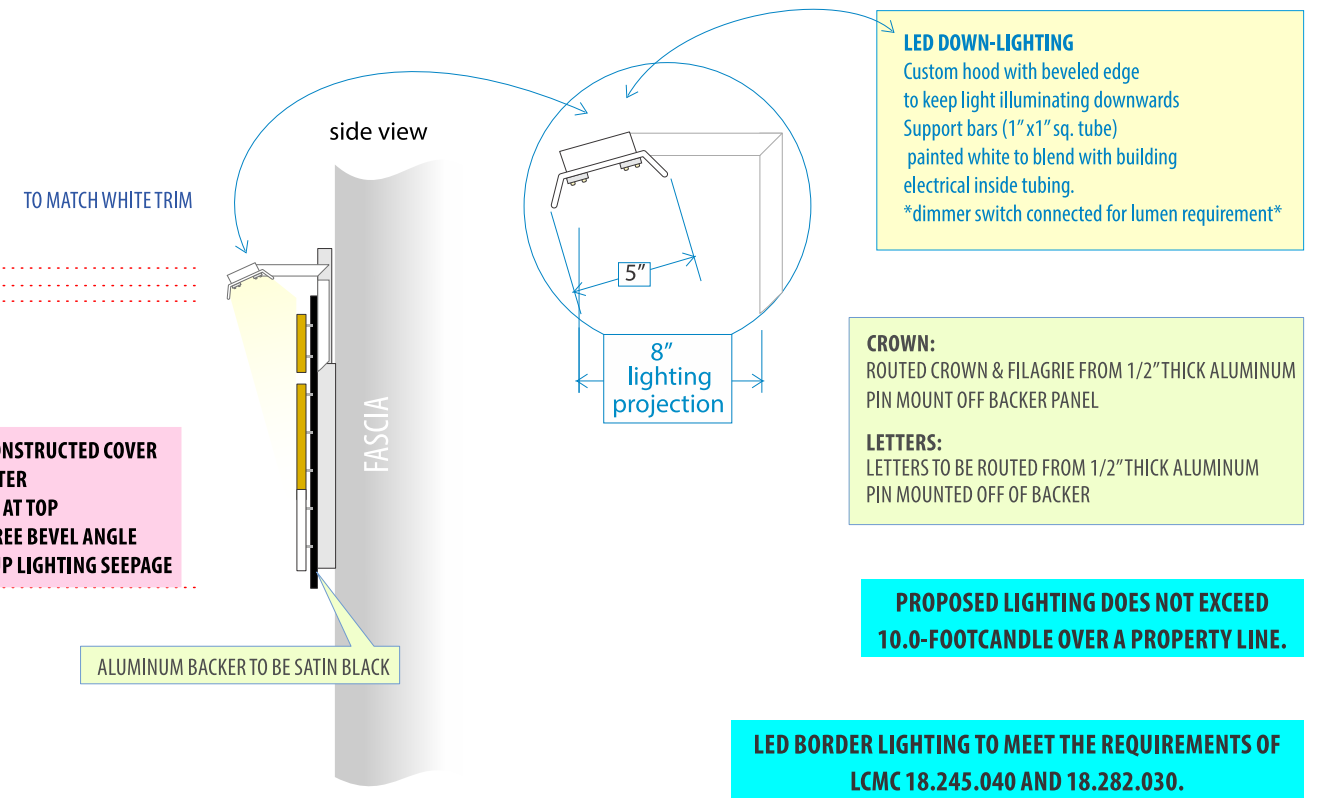

COPY & LOGO 33" x 89" = 20.3 sq. ft. total



ALUMINUM CONSTRUCTED COVER
REVERSE GUTTER
6" OVERHANG AT TOP
WITH 30 DEGREE BEVEL ANGLE
TO PREVENT UP LIGHTING SEEPAGE

LED DOWN-LIGHTING
Custom hood with beveled edge to keep light illuminating downwards
Support bars (1" x 1" sq. tube) painted white to blend with building electrical inside tubing.
dimmer switch connected for lumen requirement

CROWN:
ROUTED CROWN & FILAGRIE FROM 1/2" THICK ALUMINUM PIN MOUNT OFF BACKER PANEL
LETTERS:
LETTERS TO BE ROUTED FROM 1/2" THICK ALUMINUM PIN MOUNTED OFF OF BACKER

PROPOSED LIGHTING DOES NOT EXCEED 10.0-FOOT CANDLE OVER A PROPERTY LINE.

LED BORDER LIGHTING TO MEET THE REQUIREMENTS OF LCMC 18.245.040 AND 18.282.030.



Shop:
6545b 5th Ave. South
Seattle WA 98101
Mail:
PO Box 3505
Seattle WA 98124

Client
Pat Hosier
Regional Manager
TIL Gaming and Fortune Casinos
Work: 425.228.3700 x-102
Cell: 206.300.3439
318 NW Pacific Hwy
La Center, WA 98629

Date:
11.14.18
Project Manager:
Jose' Martinez
Designer: mm

CLIENT APPROVAL
DATE: _____
BY: _____
LANDLORD APPROVAL
DATE: _____
BY: _____

Revisions/Date:

THIS DESIGN IS THE EXPRESS PROPERTY OF GRAPHIC DISPLAY SIGN CO. AND IS PROTECTED BY FEDERAL COPYRIGHT LAWS. ANY REPRODUCTION OF A SIGN SIMILAR TO THE DESIGN REPRESENTED HEREIN IS FORBIDDEN. SHOULD THIS OCCUR, GRAPHIC DISPLAY IS DUE \$1000.00 AS COMPENSATION FOR CREATION OF SAID DESIGN.
 SIGN(S) TO BE MANUFACTURED TO U.L. SPECIFICATIONS AND WILL BEAR THE U.L. LABEL(S). INSTALL IN ACCORDANCE WITH NATIONAL ELECTRICAL CODES.

✓ **COMPLETED** ALL LIGHTING IS FACING DOWNWARD ON ALL WALL SIGNS.

✓ **COMPLETED** BAFFEL ADDED OVER TOPS OF LIGHTS & DIMMERS ADDED TO ALL LIGHTING

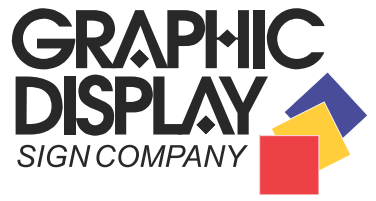
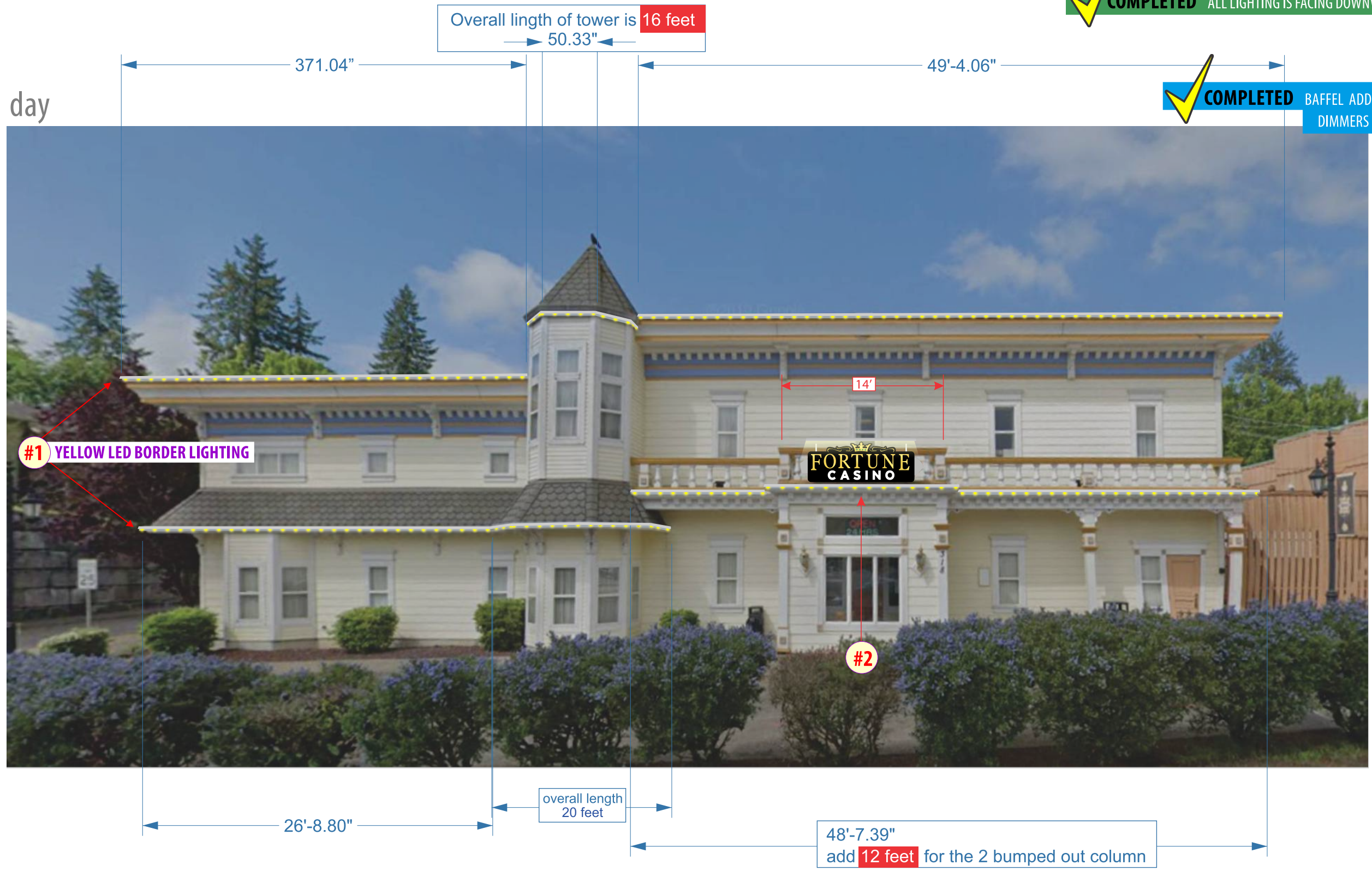

Shop:
6545b 5th Ave. South
Seattle WA 98101
Mail:
PO Box 3505
Seattle WA 98124

Client
Pat Hosier
Regional Manager
TIL Gaming and Fortune Casinos
Work: 425.228.3700 x-102
Cell: 206.300.3439

318 NW Pacific Hwy
La Center, WA 98629

Date:
11.14.18
Project Manager:
Jose' Martinez
Designer: mm

CLIENT APPROVAL
DATE: _____
BY: _____
LANDLORD APPROVAL
DATE: _____
BY: _____

Revisions/Date:

THIS DESIGN IS THE EXPRESS PROPERTY OF GRAPHIC DISPLAY SIGN CO. AND IS PROTECTED BY FEDERAL COPYRIGHT LAWS. ANY REPRODUCTION OF A SIGN SIMILAR TO THE DESIGN REPRESENTED HEREIN IS FORBIDDEN. SHOULD THIS OCCUR, GRAPHIC DISPLAY IS DUE \$1000.00 AS COMPENSATION FOR CREATION OF SAID DESIGN.

SIGN(S) TO BE MANUFACTURED TO U.L. SPECIFICATIONS AND WILL BEAR THE U.L. LABEL(S). INSTALL IN ACCORDANCE WITH NATIONAL ELECTRICAL CODES.

File name
FortuneCasino_LaCenter_V10_permits

night

✓ **COMPLETED** ALL LIGHTING IS FACING DOWNWARD ON ALL WALL SIGNS.

✓ **COMPLETED** BAFFEL ADDED OVER TOPS OF LIGHTS & DIMMERS ADDED TO ALL LIGHTING



Shop:
6545b 5th Ave. South
Seattle WA 98101
Mail:
PO Box 3505
Seattle WA 98124

Client
Pat Hosier
Regional Manager
TIL Gaming and Fortune Casinos
Work: 425.228.3700 x-102
Cell: 206.300.3439

318 NW Pacific Hwy
La Center, WA 98629

Date:
11.14.18

Project Manager:
Jose' Martinez

Designer: **mm**

CLIENT APPROVAL
DATE: _____
BY: _____

LANDLORD APPROVAL
DATE: _____
BY: _____

Revisions/Date:

THIS DESIGN IS THE EXPRESS PROPERTY OF GRAPHIC DISPLAY SIGN CO. AND IS PROTECTED BY FEDERAL COPYRIGHT LAWS. ANY REPRODUCTION OF A SIGN SIMILAR TO THE DESIGN REPRESENTED HEREIN IS FORBIDDEN. SHOULD THIS OCCUR, GRAPHIC DISPLAY IS DUE \$1000.00 AS COMPENSATION FOR CREATION OF SAID DESIGN.

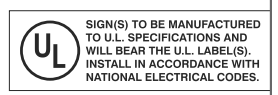

File name
FortuneCasino_LaCenter_V10_permits

#3 RE FURBISH EXISTING PYLON SIGN

PREVIOUS

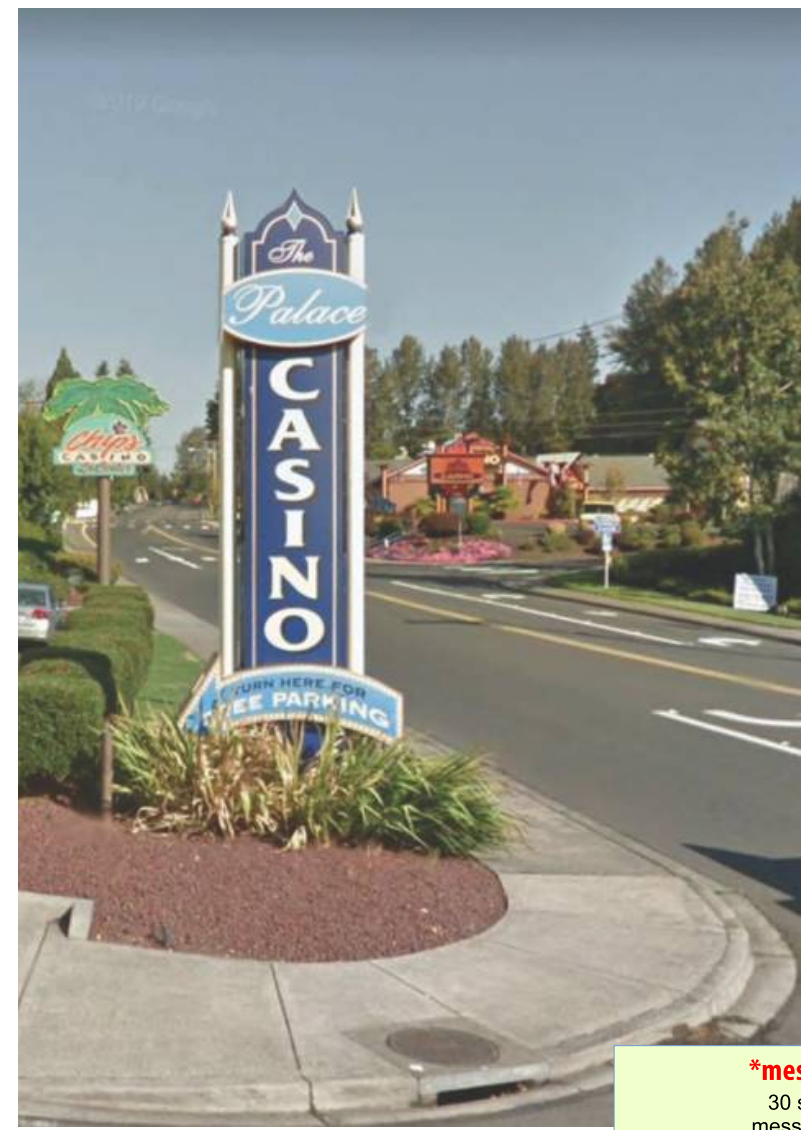

DAY



NIGHT

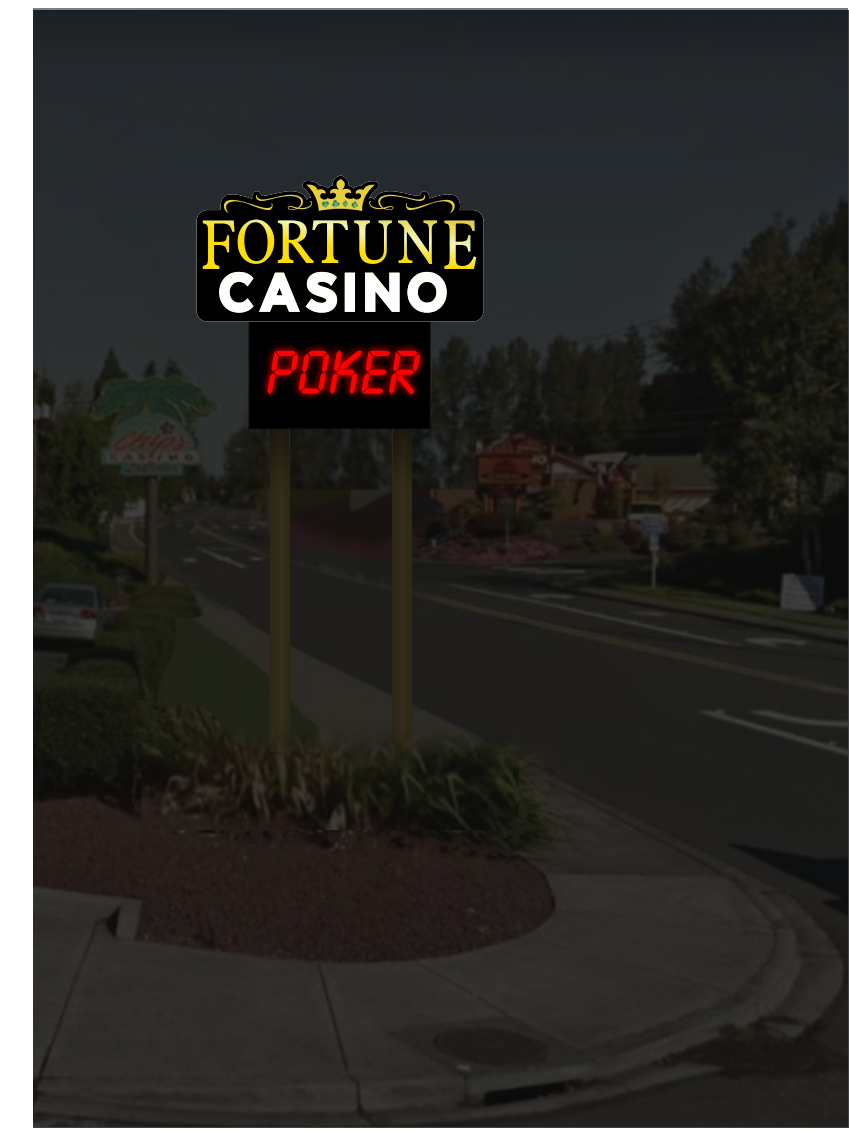

message unit notes
 30 s/f message center messages to change no faster than 8 seconds apart
 not exceed 100 nits during nighttime hours and 5,000 nits during daylight hours.

#3 RE FURBISH EXISTING PYLON SIGN

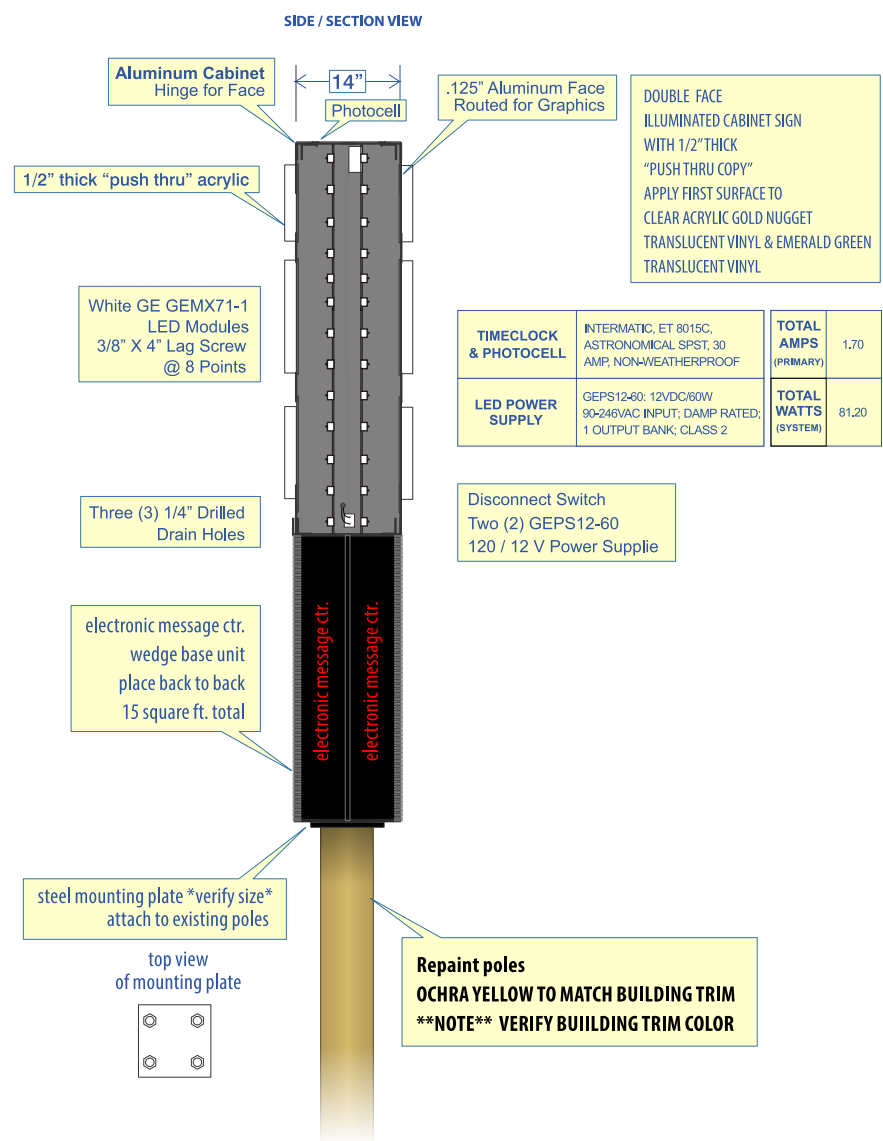

- COLORS**
- BLACK
 - WHITE
 - OCHRE COLOR (TO MATCH BUILDING TRIM)
VERIFY COLOR
 - GOLD NUGGET
 - EMERALD GREEN

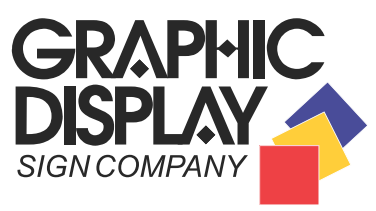

Shop:
6545b 5th Ave. South
Seattle WA 98101
Mail:
PO Box 3505
Seattle WA 98124

Client
Pat Hosier
Regional Manager
TIL Gaming and Fortune Casinos
Work: 425.228.3700 x-102
Cell: 206.300.3439
318 NW Pacific Hwy
La Center, WA 98629

Date:
11.14.18
Project Manager:
Jose' Martinez
Designer: mm

CLIENT APPROVAL
DATE: _____
BY: _____
LANDLORD APPROVAL
DATE: _____
BY: _____

Revisions/Date:



#4 WALL SIGN

FABRICATE & INSTALL ONE (1) SINGLE FACE EXTERNALLY ILLUMINATED WALL SIGN.



COPY & LOGO 33" x 89" = 20.3 sq. ft. total

CROWN:
ROUTED CROWN & FILAGRIE FROM 1/2" THICK ALUMINUM
PIN MOUNT OFF BACKER PANEL

LETTERS:
LETTERS TO BE ROUTED FROM 1/2" THICK ALUMINUM
PIN MOUNTED OFF OF BACKER

Previous



Remove & Recycle
use existing supports & elec. connection



84.22"

TO MATCH WHITE TRIM

ALUMINUM CONSTRUCTED COVER
REVERSE GUTTER
6" OVERHANG AT TOP
WITH 30 DEGREE BEVEL ANGLE
TO PREVENT UP LIGHTING SEEPAGE

ALUMINUM BACKER TO BE SATIN BLACK

side view

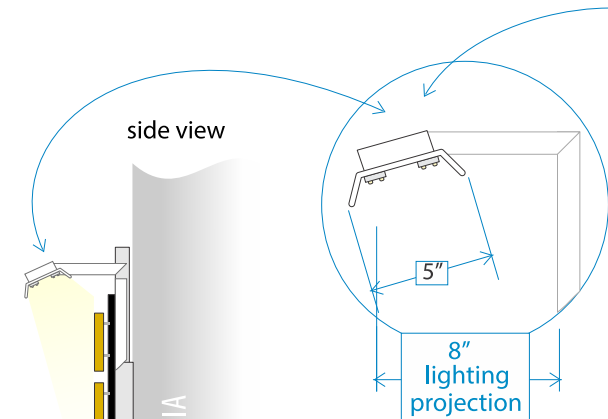

LED DOWN-LIGHTING
Custom hood with beveled edge
to keep light illuminating downwards
Support bars (1" x 1" sq. tube)
painted white to blend with building
electrical inside tubing.
dimmer switch connected for lumen requirement

COMPLETED ALL LIGHTING IS FACING DOWNWARD ON ALL WALL SIGNS.

COMPLETED BAFFEL ADDED OVER TOPS OF LIGHTS & DIMMERS ADDED TO ALL LIGHTING

PLOT PLAN



ENLARGED VIEW

