

DESCRIPTION

The Galleon™ LED luminaire delivers exceptional performance in a highly scalable, low-profile design. Patented, high-efficiency AccuLED Optics™ system provides uniform and energy conscious illumination to walkways, parking lots, roadways, building areas and security lighting applications. IP66 rated and UL/cUL Listed for wet locations.

Catalog #		Type
Project		
Comments		Date
Prepared by		

SPECIFICATION FEATURES

Construction

Extruded aluminum driver enclosure thermally isolated from Light Squares for optimal thermal performance. Heavy-wall, die-cast aluminum end caps enclose housing and die-cast aluminum heat sinks. A unique, patent pending interlocking housing and heat sink provides scalability with superior structural rigidity. 3G vibration tested and rated. Optional tool-less hardware available for ease of entry into electrical chamber. Housing is IP66 rated.

Optics

Patented, high-efficiency injection-molded AccuLED Optics technology. Optics are precisely designed to shape the distribution maximizing efficiency and application spacing. AccuLED Optics create consistent distributions with the scalability to meet customized application requirements. Offered standard in 4000K (+/- 275K) CCT 70 CRI. Optional 3000K, 5000K and 6000K CCT.

Electrical

LED drivers are mounted to removable tray assembly for ease of maintenance. 120-277V 50/60Hz, 347V 60Hz or 480V 60Hz operation. 480V is compatible for use with 480V Wye systems only. Standard with 0-10V dimming. Shipped standard with Eaton proprietary circuit module designed to withstand 10kV of transient line surge. The Galleon LED luminaire is suitable for operation in -40°C to 40°C ambient environments. For applications with ambient temperatures exceeding 40°C, specify the HA (High Ambient) option. Light Squares are IP66 rated. Greater than 90% lumen maintenance expected at 60,000 hours. Available in standard 1A drive current and optional 600mA, 800mA and 1200mA drive currents (nominal).

Mounting

STANDARD ARM MOUNT: Extruded aluminum arm includes internal bolt guides allowing for easy positioning of fixture during mounting. When mounting two or more luminaires at 90° and 120° apart, the EA extended arm may be required. Refer to the

arm mounting requirement table. Round pole adapter included. For wall mounting, specify wall mount bracket option. **QUICK MOUNT ARM:** Adapter is bolted directly to the pole. Quick mount arm slide into place on the adapter and is secured via two screws, facilitating quick and easy installation. The versatile, patent pending, quick mount arm accommodates multiple drill patterns ranging from 1-1/2" to 4-7/8". Removal of the door on the quick mount arm enables wiring of the fixture without having to access the driver compartment. A knock-out enables round pole mounting.

Finish

Housing finished in super durable TGIC polyester powder coat paint, 2.5 mil nominal thickness for superior protection against fade and wear. Heat sink is powder coated black. Standard housing colors include black, bronze, grey, white, dark platinum and graphite metallic. RAL and custom color matches available.

Warranty

Five-year warranty.



GLEON GALLEON LED

1-10 Light Squares
Solid State LED

AREA/SITE LUMINAIRE

DIMENSIONS

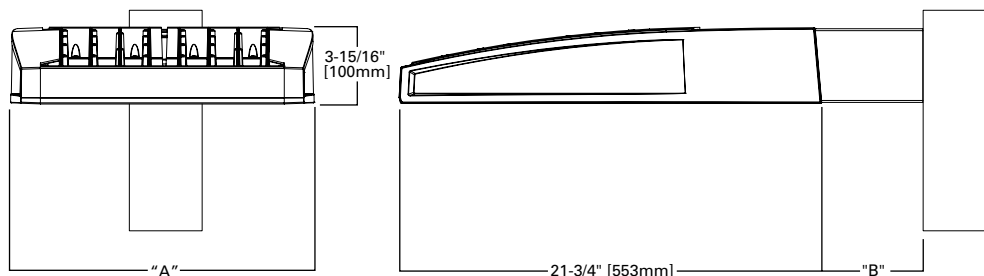

DIMENSION DATA

Number of Light Squares	"A" Width	"B" Standard Arm Length	"B" Optional Arm Length ¹	Weight with Arm (lbs.)	EPA with Arm ² (Sq. Ft.)
1-4	15-1/2" (394mm)	7" (178mm)	10" (254mm)	33 (15.0 kgs.)	0.96
5-6	21-5/8" (549mm)	7" (178mm)	10" (254mm)	44 (20.0 kgs.)	1.00
7-8	27-5/8" (702mm)	7" (178mm)	13" (330mm)	54 (24.5 kgs.)	1.07
9-10	33-3/4" (857mm)	7" (178mm)	16" (406mm)	63 (28.6 kgs.)	1.12

NOTES: 1. Optional arm length to be used when mounting two fixtures at 90° on a single pole. 2. EPA calculated with optional arm length.

DRILLING PATTERN

TYPE "N"

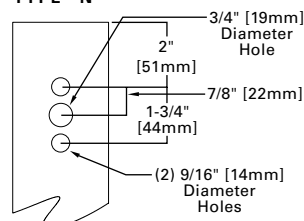

CERTIFICATION DATA

UL/cUL Wet Location Listed
ISO 9001
LM79 / LM80 Compliant
3G Vibration Rated
IP66 Rated
DesignLights Consortium® Qualified*

ENERGY DATA

Electronic LED Driver
>0.9 Power Factor
<20% Total Harmonic Distortion
120V-277V 50/60Hz
347V & 480V 60Hz
-40°C Min. Temperature
40°C Max. Temperature
50°C Max. Temperature (HA Option)

ARM MOUNTING REQUIREMENTS

Configuration	90° Apart	120° Apart
GLEON-AF-01	7" Arm (Standard)	7" Arm (Standard)
GLEON-AF-02	7" Arm (Standard)	7" Arm (Standard)
GLEON-AF-03	7" Arm (Standard)	7" Arm (Standard)
GLEON-AF-04	7" Arm (Standard)	7" Arm (Standard)
GLEON-AF-05	10" Extended Arm (Required)	7" Arm (Standard)
GLEON-AF-06	10" Extended Arm (Required)	7" Arm (Standard)
GLEON-AF-07	13" Extended Arm (Required)	13" Extended Arm (Required)
GLEON-AF-08	13" Extended Arm (Required)	13" Extended Arm (Required)
GLEON-AF-09	16" Extended Arm (Required)	16" Extended Arm (Required)
GLEON-AF-10	16" Extended Arm (Required)	16" Extended Arm (Required)

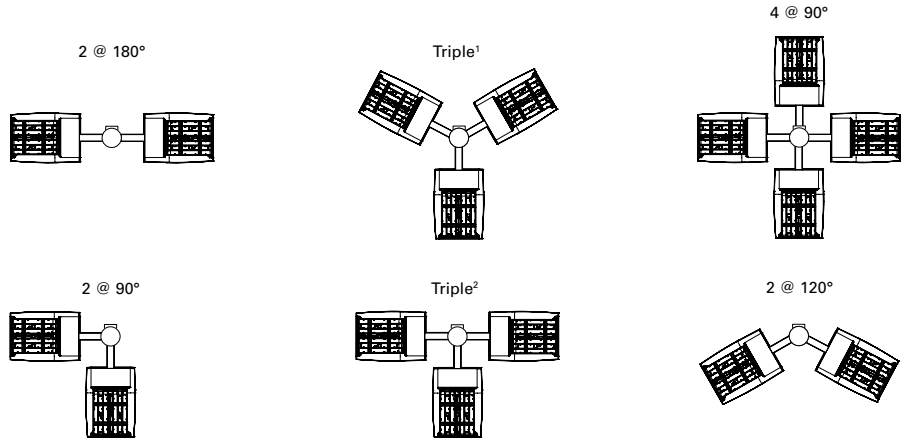

NOTES: 1 Round poles are 3 @ 120°. Square poles are 3 @ 90°. 2 Round poles are 3 @ 90°.

STANDARD WALL MOUNT

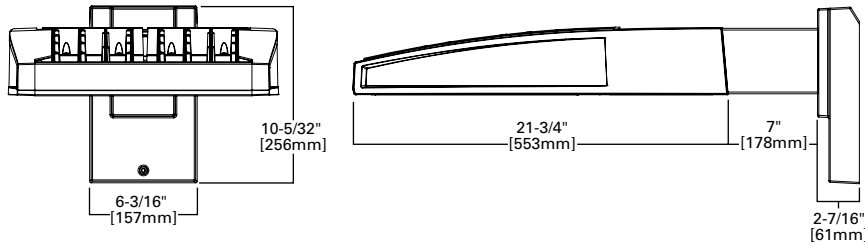

MAST ARM MOUNT

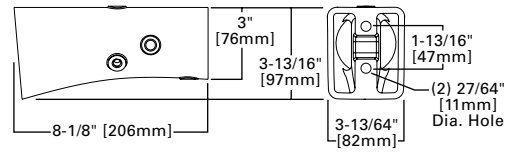

QUICK MOUNT ARM (INCLUDES FIXTURE ADAPTER)

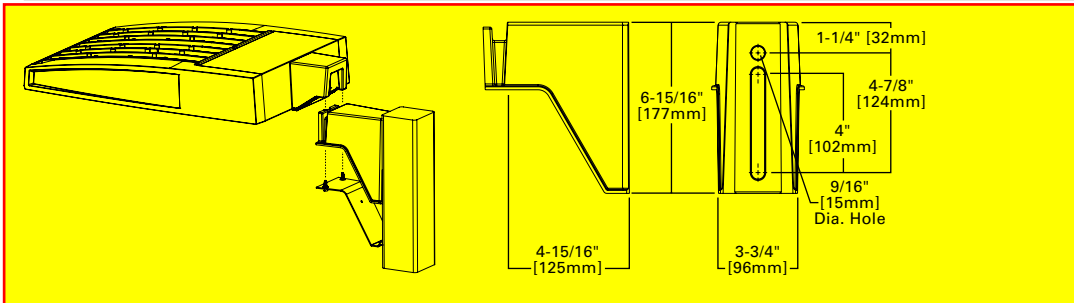

fixed arm, no adjustment

QM Quick Mount Arm (Standard)

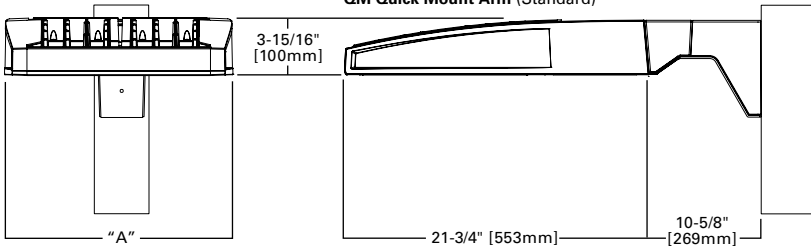

QMEA Quick Mount Arm (Extended)

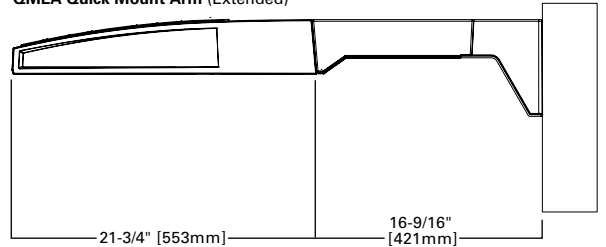

QUICK MOUNT ARM DATA

Number of Light Squares ^{1,2}	"A" Width	Weight with QM Arm (lbs.)	Weight with QMEA Arm (lbs.)	EPA (Sq. Ft.)
1-4	15-1/2" (394mm)	35 (15.91 kgs.)	38 (17.27 kgs.)	1.11
5-6 ³	21-5/8" (549mm)	46 (20.91 kgs.)	49 (22.27 kgs.)	
7-8	27-5/8" (702mm)	56 (25.45 kgs.)	59 (26.82 kgs.)	

NOTES: 1 QM option available with 1-8 light square configurations. 2 QMEA option available with 1-6 light square configurations. 3 QMEA arm to be used when mounting two fixtures at 90° on a single pole.

OPTIC ORIENTATION

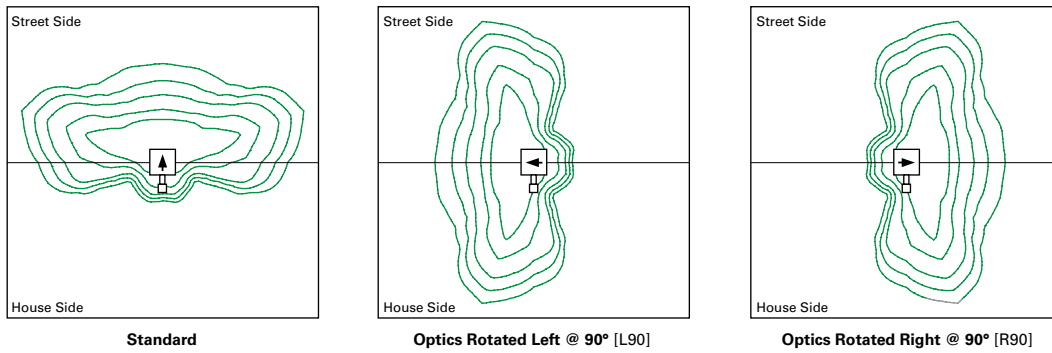

OPTICAL DISTRIBUTIONS

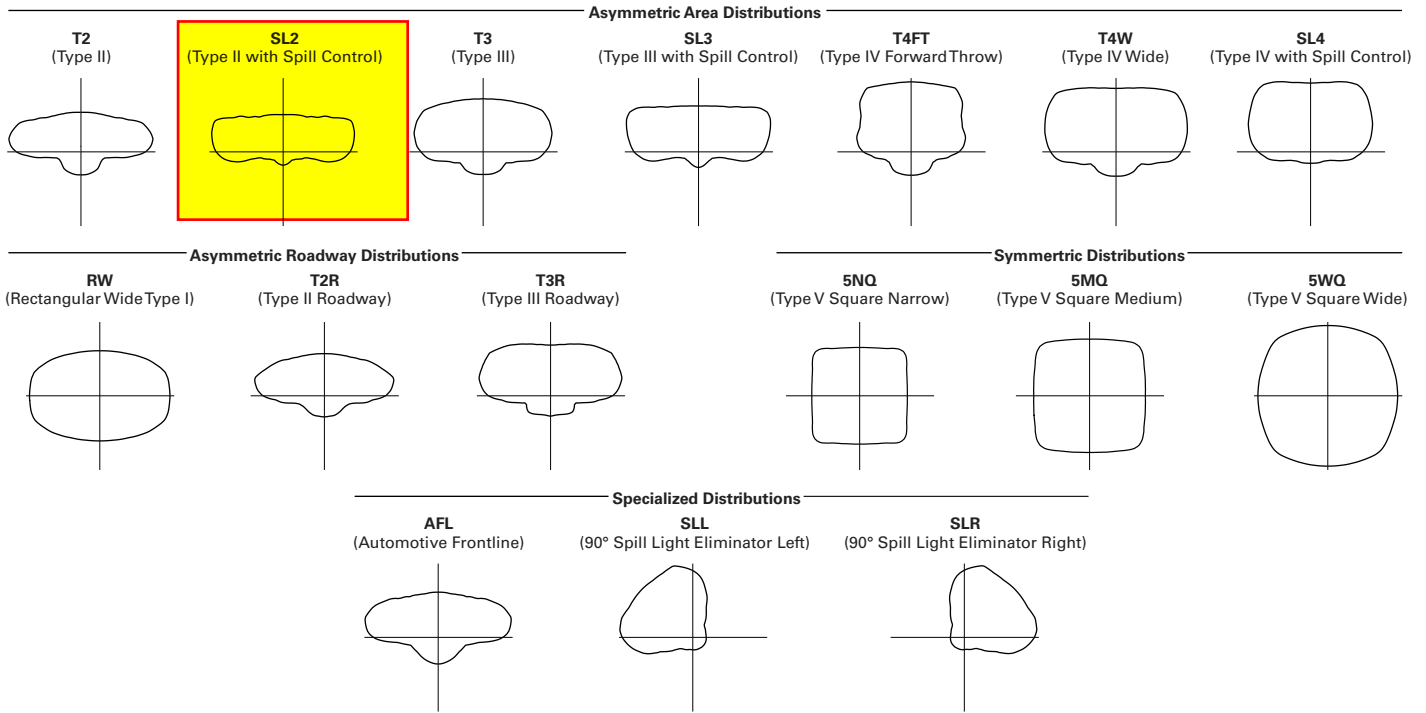

LUMEN MAINTENANCE

Drive Current	Ambient Temperature	TM-21 Lumen Maintenance (60,000 Hours)	Projected L70 (Hours)
Up to 1A	Up to 50°C	> 95%	416,000
1.2A	Up to 40°C	> 90%	205,000

LUMEN MULTIPLIER

Ambient Temperature	Lumen Multiplier
0°C	1.02
10°C	1.01
25°C	1.00
40°C	0.99
50°C	0.97

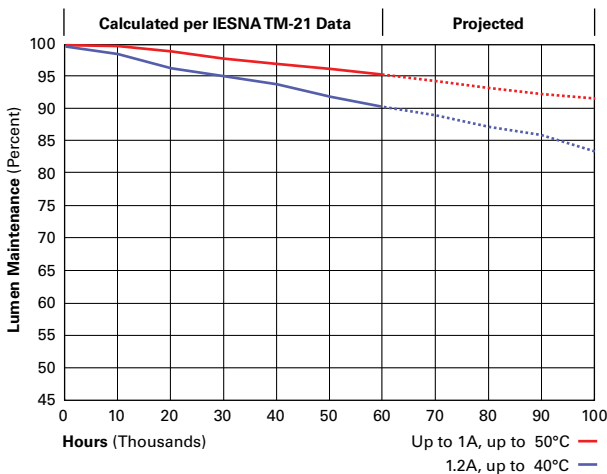

NOMINAL POWER LUMENS (1.2A)

Number of Light Squares	1	2	3	4	5	6	7	8	9	10	
Nominal Power (Watts)	67	129	191	258	320	382	448	511	575	640	
Input Current @ 120V (A)	0.58	1.16	1.78	2.31	2.94	3.56	4.09	4.71	5.34	5.87	
Input Current @ 208V (A)	0.33	0.63	0.93	1.27	1.57	1.87	2.22	2.52	2.8	3.14	
Input Current @ 240V (A)	0.29	0.55	0.80	1.10	1.35	1.61	1.93	2.18	2.41	2.71	
Input Current @ 277V (A)	0.25	0.48	0.70	0.96	1.18	1.39	1.69	1.90	2.09	2.36	
Input Current @ 347V (A)	0.20	0.39	0.57	0.78	0.96	1.15	1.36	1.54	1.72	1.92	
Input Current @ 480V (A)	0.15	0.30	0.43	0.60	0.73	0.85	1.03	1.16	1.28	1.45	
Optics											
T2	4000K/5000K Lumens	6,709	13,111	19,562	25,848	32,026	38,325	45,324	51,355	57,286	63,424
	3000K Lumens	5,939	11,606	17,316	22,881	28,349	33,925	40,121	45,459	50,710	56,143
	BUG Rating	B1-U0-G2	B2-U0-G2	B3-U0-G3	B3-U0-G4	B3-U0-G4	B3-U0-G5	B4-U0-G5	B4-U0-G5	B4-U0-G5	B4-U0-G5
T2R	4000K/5000K Lumens	7,122	13,919	20,769	27,442	34,000	40,687	48,117	54,519	60,816	67,333
	3000K Lumens	5,939	11,606	17,316	22,881	28,349	33,925	40,121	45,459	50,710	56,143
	BUG Rating	B1-U0-G1	B2-U0-G2	B2-U0-G3	B3-U0-G3	B3-U0-G4	B3-U0-G4	B3-U0-G5	B3-U0-G5	B4-U0-G5	B4-U0-G5
T3	4000K/5000K Lumens	6,838	13,363	19,939	26,346	32,642	39,062	46,196	52,343	58,388	64,646
	3000K Lumens	6,053	11,829	17,650	23,321	28,895	34,578	40,893	46,334	51,685	57,225
	BUG Rating	B1-U0-G2	B2-U0-G2	B3-U0-G3	B3-U0-G4	B3-U0-G4	B3-U0-G5	B4-U0-G5	B4-U0-G5	B4-U0-G5	B4-U0-G5
T3R	4000K/5000K Lumens	6,990	13,660	20,382	26,931	33,368	39,930	47,223	53,506	59,686	66,081
	3000K Lumens	6,188	12,092	18,042	23,839	29,537	35,346	41,802	47,364	52,834	58,495
	BUG Rating	B1-U0-G2	B2-U0-G3	B2-U0-G3	B3-U0-G4	B3-U0-G5	B3-U0-G5	B3-U0-G5	B3-U0-G5	B4-U0-G5	B4-U0-G5
T4FT	4000K/5000K Lumens	6,878	13,440	20,055	26,499	32,832	39,289	46,464	52,646	58,726	65,020
	3000K Lumens	6,088	11,897	17,753	23,457	29,063	34,779	41,130	46,602	51,984	57,556
	BUG Rating	B1-U0-G2	B2-U0-G3	B2-U0-G4	B3-U0-G4	B3-U0-G5	B3-U0-G5	B3-U0-G5	B4-U0-G5	B4-U0-G5	B4-U0-G5
T4W	4000K/5000K Lumens	6,789	13,267	19,795	26,156	32,408	38,781	45,864	51,967	57,968	64,180
	3000K Lumens	6,010	11,744	17,523	23,153	28,688	34,329	40,599	46,001	51,313	56,812
	BUG Rating	B1-U0-G2	B2-U0-G3	B3-U0-G4	B3-U0-G4	B3-U0-G5	B3-U0-G5	B4-U0-G5	B4-U0-G5	B4-U0-G5	B4-U0-G5
SL2	4000K/5000K Lumens	6,697	13,088	19,529	25,804	31,970	38,259	45,245	51,267	57,186	63,315
	3000K Lumens	5,928	11,585	17,287	22,842	28,300	33,867	40,051	45,382	50,621	56,046
	BUG Rating	B1-U0-G2	B2-U0-G3	B3-U0-G3	B3-U0-G4	B3-U0-G4	B3-U0-G5	B4-U0-G5	B4-U0-G5	B4-U0-G5	B4-U0-G5
SL3	4000K/5000K Lumens	6,837	13,361	19,936	26,342	32,639	39,057	46,189	52,336	58,380	64,636
	3000K Lumens	6,052	11,827	17,647	23,318	28,892	34,573	40,887	46,328	51,678	57,216
	BUG Rating	B1-U0-G2	B2-U0-G3	B2-U0-G4	B3-U0-G4	B3-U0-G5	B3-U0-G5	B3-U0-G5	B4-U0-G5	B4-U0-G5	B4-U0-G5
SL4	4000K/5000K Lumens	6,496	12,695	18,943	25,029	31,011	37,110	43,886	49,727	55,470	61,414
	3000K Lumens	5,750	11,238	16,768	22,156	27,451	32,850	38,848	44,018	49,102	54,364
	BUG Rating	B1-U0-G2	B1-U0-G3	B2-U0-G4	B2-U0-G4	B2-U0-G5	B3-U0-G5	B3-U0-G5	B3-U0-G5	B3-U0-G5	B3-U0-G5
5NQ	4000K/5000K Lumens	7,052	13,781	20,564	27,171	33,664	40,285	47,641	53,981	60,215	66,669
	3000K Lumens	6,242	12,199	18,203	24,052	29,799	35,660	42,172	47,784	53,302	59,015
	BUG Rating	B3-U0-G1	B3-U0-G2	B4-U0-G2	B4-U0-G2	B5-U0-G2	B5-U0-G3	B5-U0-G3	B5-U0-G4	B5-U0-G4	B5-U0-G4
5MQ	4000K/5000K Lumens	7,182	14,034	20,942	27,671	34,284	41,027	48,518	54,975	61,323	67,896
	3000K Lumens	6,358	12,423	18,538	24,494	30,348	36,317	42,948	48,664	54,283	60,102
	BUG Rating	B3-U0-G1	B4-U0-G2	B4-U0-G2	B5-U0-G3	B5-U0-G4	B5-U0-G4	B5-U0-G4	B5-U0-G5	B5-U0-G5	B5-U0-G5
5WQ	4000K/5000K Lumens	7,201	14,073	20,998	27,744	34,375	41,136	48,648	55,121	61,487	68,077
	3000K Lumens	6,374	12,457	18,587	24,559	30,429	36,414	43,063	48,793	54,428	60,262
	BUG Rating	B3-U0-G2	B4-U0-G2	B5-U0-G3	B5-U0-G4	B5-U0-G4	B5-U0-G4	B5-U0-G5	B5-U0-G5	B5-U0-G5	B5-U0-G5
SLL/SLR	4000K/5000K Lumens	6,009	11,741	17,519	23,148	28,681	34,321	40,589	45,990	51,301	56,798
	3000K Lumens	5,319	10,393	15,508	20,491	25,388	30,381	35,929	40,710	45,412	50,278
	BUG Rating	B1-U0-G2	B2-U0-G3	B2-U0-G3	B3-U0-G4	B3-U0-G4	B3-U0-G5	B3-U0-G5	B3-U0-G5	B3-U0-G5	B4-U0-G5
RW	4000K/5000K Lumens	6,989	13,657	20,378	26,925	33,360	39,921	47,211	53,494	59,672	66,066
	3000K Lumens	6,187	12,089	18,039	23,834	29,530	35,338	41,791	47,353	52,822	58,482
	BUG Rating	B3-U0-G1	B3-U0-G2	B4-U0-G2	B4-U0-G2	B5-U0-G3	B5-U0-G3	B5-U0-G4	B5-U0-G4	B5-U0-G4	B5-U0-G4
AFL	4000K/5000K Lumens	7,014	13,706	20,452	27,023	33,481	40,066	47,383	53,688	59,888	66,306
	3000K Lumens	6,209	12,133	18,104	23,921	29,637	35,466	41,943	47,525	53,013	58,694
	BUG Rating	B1-U0-G1	B2-U0-G2	B2-U0-G2	B3-U0-G3	B3-U0-G3	B3-U0-G3	B3-U0-G3	B3-U0-G4	B4-U0-G4	B4-U0-G4

* Nominal data for 70 CRI.

NOMINAL POWER LUMENS (1A)

Number of Light Squares	1	2	3	4	5	6	7	8	9	10	
Nominal Power (Watts)	59	113	166	225	279	333	391	445	501	558	
Input Current @ 120V (A)	0.51	1.02	1.53	2.03	2.55	3.06	3.56	4.08	4.6	5.07	
Input Current @ 208V (A)	0.29	0.56	0.82	1.11	1.37	1.64	1.93	2.19	2.46	2.75	
Input Current @ 240V (A)	0.26	0.48	0.71	0.96	1.19	1.41	1.67	1.89	2.12	2.39	
Input Current @ 277V (A)	0.23	0.42	0.61	0.83	1.03	1.23	1.45	1.65	1.84	2.09	
Input Current @ 347V (A)	0.17	0.32	0.50	0.64	0.82	1.00	1.14	1.32	1.50	1.68	
Input Current @ 480V (A)	0.14	0.24	0.37	0.48	0.61	0.75	0.91	0.99	1.12	1.28	
Optics											
T2	4000K/5000K Lumens	6,116	11,951	17,833	23,563	29,195	34,937	41,317	46,814	52,221	57,817
	3000K Lumens	5,414	10,579	15,786	20,858	25,843	30,926	36,574	41,440	46,226	51,180
	BUG Rating	B1-U0-G2	B2-U0-G2	B3-U0-G3	B3-U0-G3	B3-U0-G4	B3-U0-G4	B4-U0-G5	B4-U0-G5	B4-U0-G5	B4-U0-G5
T2R	4000K/5000K Lumens	6,493	12,688	18,932	25,015	30,994	37,090	43,863	49,699	55,439	61,380
	3000K Lumens	5,748	11,231	16,759	22,143	27,436	32,832	38,828	43,994	49,075	54,334
	BUG Rating	B1-U0-G1	B2-U0-G2	B2-U0-G2	B3-U0-G3	B3-U0-G4	B3-U0-G4	B3-U0-G4	B3-U0-G5	B4-U0-G5	B4-U0-G5
T3	4000K/5000K Lumens	6,234	12,181	18,176	24,017	29,756	35,609	42,111	47,715	53,225	58,930
	3000K Lumens	5,518	10,783	16,089	21,260	26,340	31,521	37,277	42,237	47,115	52,165
	BUG Rating	B1-U0-G2	B2-U0-G2	B3-U0-G3	B3-U0-G4	B3-U0-G4	B3-U0-G5	B4-U0-G5	B4-U0-G5	B4-U0-G5	B4-U0-G5
T3R	4000K/5000K Lumens	6,372	12,453	18,580	24,550	30,418	36,400	43,048	48,776	54,409	60,239
	3000K Lumens	5,640	11,023	16,447	21,732	26,926	32,221	38,106	43,177	48,163	53,324
	BUG Rating	B1-U0-G2	B2-U0-G2	B2-U0-G3	B3-U0-G4	B3-U0-G4	B3-U0-G5	B3-U0-G5	B3-U0-G5	B3-U0-G5	B4-U0-G5
T4FT	4000K/5000K Lumens	6,270	12,252	18,282	24,156	29,929	35,815	42,356	47,992	53,534	59,271
	3000K Lumens	5,550	10,845	16,183	21,383	26,493	31,703	37,494	42,483	47,388	52,467
	BUG Rating	B1-U0-G2	B2-U0-G2	B2-U0-G3	B3-U0-G4	B3-U0-G5	B3-U0-G5	B3-U0-G5	B3-U0-G5	B4-U0-G5	B4-U0-G5
T4W	4000K/5000K Lumens	6,189	12,094	18,045	23,844	29,543	35,352	41,809	47,372	52,843	58,506
	3000K Lumens	5,479	10,706	15,973	21,107	26,151	31,294	37,009	41,934	46,777	51,790
	BUG Rating	B1-U0-G2	B2-U0-G2	B3-U0-G3	B3-U0-G4	B3-U0-G5	B3-U0-G5	B4-U0-G5	B4-U0-G5	B4-U0-G5	B4-U0-G5
SL2	4000K/5000K Lumens	6,105	11,931	17,803	23,522	29,144	34,877	41,245	46,734	52,130	57,717
	3000K Lumens	5,404	10,561	15,759	20,822	25,798	30,873	36,510	41,369	46,145	51,091
	BUG Rating	B1-U0-G2	B2-U0-G3	B3-U0-G3	B3-U0-G4	B3-U0-G4	B3-U0-G5	B4-U0-G5	B4-U0-G5	B4-U0-G5	B4-U0-G5
SL3	4000K/5000K Lumens	6,233	12,180	18,174	24,013	29,753	35,604	42,106	47,708	53,218	58,921
	3000K Lumens	5,517	10,782	16,088	21,256	26,337	31,517	37,272	42,231	47,109	52,157
	BUG Rating	B1-U0-G2	B2-U0-G3	B2-U0-G3	B3-U0-G4	B3-U0-G4	B3-U0-G5	B3-U0-G5	B3-U0-G5	B4-U0-G5	B4-U0-G5
SL4	4000K/5000K Lumens	5,922	11,572	17,268	22,816	28,269	33,829	40,006	45,330	50,566	55,984
	3000K Lumens	5,242	10,244	15,286	20,197	25,024	29,945	35,413	40,126	44,761	49,557
	BUG Rating	B1-U0-G2	B1-U0-G3	B2-U0-G3	B2-U0-G4	B2-U0-G5	B3-U0-G5	B3-U0-G5	B3-U0-G5	B3-U0-G5	B3-U0-G5
5NQ	4000K/5000K Lumens	6,429	12,563	18,746	24,768	30,688	36,723	43,429	49,208	54,891	60,775
	3000K Lumens	5,691	11,121	16,594	21,925	27,165	32,507	38,443	43,559	48,590	53,798
	BUG Rating	B2-U0-G1	B3-U0-G2	B4-U0-G2	B4-U0-G2	B5-U0-G2	B5-U0-G3	B5-U0-G3	B5-U0-G3	B5-U0-G4	B5-U0-G4
5MQ	4000K/5000K Lumens	6,547	12,794	19,090	25,224	31,253	37,400	44,228	50,114	55,902	61,893
	3000K Lumens	5,795	11,325	16,898	22,328	27,665	33,106	39,151	44,361	49,484	54,788
	BUG Rating	B3-U0-G1	B4-U0-G2	B4-U0-G2	B5-U0-G3	B5-U0-G3	B5-U0-G4	B5-U0-G4	B5-U0-G4	B5-U0-G5	B5-U0-G5
5WQ	4000K/5000K Lumens	6,564	12,828	19,141	25,291	31,336	37,499	44,347	50,248	56,051	62,058
	3000K Lumens	5,810	11,355	16,944	22,388	27,739	33,194	39,256	44,480	49,616	54,934
	BUG Rating	B3-U0-G2	B4-U0-G2	B5-U0-G3	B5-U0-G3	B5-U0-G4	B5-U0-G4	B5-U0-G5	B5-U0-G5	B5-U0-G5	B5-U0-G5
SLL/SLR	4000K/5000K Lumens	5,478	10,703	15,970	21,102	26,145	31,286	37,001	41,924	46,765	51,777
	3000K Lumens	4,849	9,474	14,137	18,679	23,144	27,694	32,753	37,111	41,396	45,833
	BUG Rating	B1-U0-G2	B1-U0-G3	B2-U0-G3	B2-U0-G4	B3-U0-G4	B3-U0-G5	B3-U0-G5	B3-U0-G5	B3-U0-G5	B3-U0-G5
RW	4000K/5000K Lumens	6,371	12,449	18,576	24,544	30,411	36,392	43,037	48,764	54,396	60,225
	3000K Lumens	5,640	11,020	16,443	21,726	26,920	32,214	38,096	43,166	48,151	53,311
	BUG Rating	B3-U0-G1	B3-U0-G2	B4-U0-G2	B4-U0-G2	B5-U0-G3	B5-U0-G3	B5-U0-G3	B5-U0-G4	B5-U0-G4	B5-U0-G4
AFL	4000K/5000K Lumens	6,394	12,494	18,644	24,634	30,521	36,524	43,194	48,942	54,593	60,444
	3000K Lumens	5,660	11,060	16,504	21,806	27,017	32,331	38,235	43,323	48,326	53,505
	BUG Rating	B1-U0-G1	B2-U0-G2	B2-U0-G2	B3-U0-G2	B3-U0-G3	B3-U0-G3	B3-U0-G3	B3-U0-G3	B4-U0-G4	B4-U0-G4

* Nominal data for 70 CRI.

NOMINAL POWER LUMENS (800MA)

Number of Light Squares	1	2	3	4	5	6	7	8	9	10	
Nominal Power (Watts)	44	85	124	171	210	249	295	334	374	419	
Input Current @ 120V (A)	0.39	0.77	1.13	1.54	1.90	2.26	2.67	3.03	3.39	3.80	
Input Current @ 208V (A)	0.22	0.44	0.62	0.88	1.06	1.24	1.50	1.68	1.87	2.12	
Input Current @ 240V (A)	0.19	0.38	0.54	0.76	0.92	1.08	1.30	1.46	1.62	1.84	
Input Current @ 277V (A)	0.17	0.36	0.47	0.72	0.83	0.95	1.19	1.31	1.42	1.67	
Input Current @ 347V (A)	0.15	0.24	0.38	0.49	0.63	0.77	0.87	1.01	1.15	1.52	
Input Current @ 480V (A)	0.11	0.18	0.29	0.37	0.48	0.59	0.66	0.77	0.88	0.96	
Optics											
T2	4000K/5000K Lumens	4,941	9,656	14,408	19,038	23,588	28,227	33,382	37,823	42,191	46,713
	3000K Lumens	4,374	8,547	12,754	16,852	20,880	24,987	29,550	33,481	37,347	41,350
	BUG Rating	B1-U0-G1	B2-U0-G2	B2-U0-G2	B3-U0-G3	B3-U0-G3	B3-U0-G4	B3-U0-G4	B3-U0-G4	B4-U0-G5	B4-U0-G5
T2R	4000K/5000K Lumens	5,246	10,251	15,296	20,211	25,041	29,966	35,439	40,154	44,791	49,592
	3000K Lumens	4,644	9,074	13,540	17,891	22,166	26,526	31,371	35,544	39,649	43,899
	BUG Rating	B1-U0-G1	B1-U0-G2	B2-U0-G2	B2-U0-G3	B3-U0-G3	B3-U0-G4	B3-U0-G4	B3-U0-G4	B3-U0-G4	B3-U0-G5
T3	4000K/5000K Lumens	5,037	9,842	14,685	19,404	24,041	28,770	34,024	38,551	43,003	47,612
	3000K Lumens	4,459	8,712	12,999	17,176	21,281	25,467	30,118	34,125	38,066	42,146
	BUG Rating	B1-U0-G1	B2-U0-G2	B2-U0-G3	B3-U0-G3	B3-U0-G4	B3-U0-G4	B3-U0-G4	B3-U0-G5	B4-U0-G5	B4-U0-G5
T3R	4000K/5000K Lumens	5,148	10,061	15,011	19,835	24,576	29,409	34,780	39,408	43,959	48,669
	3000K Lumens	4,557	8,906	13,288	17,558	21,755	26,033	30,787	34,884	38,913	43,082
	BUG Rating	B1-U0-G2	B1-U0-G2	B2-U0-G3	B2-U0-G3	B3-U0-G4	B3-U0-G4	B3-U0-G5	B3-U0-G5	B3-U0-G5	B3-U0-G5
T4FT	4000K/5000K Lumens	5,066	9,899	14,770	19,516	24,181	28,936	34,221	38,774	43,252	47,888
	3000K Lumens	4,484	8,763	13,074	17,276	21,405	25,614	30,292	34,323	38,287	42,390
	BUG Rating	B1-U0-G2	B1-U0-G2	B2-U0-G3	B2-U0-G4	B3-U0-G4	B3-U0-G4	B3-U0-G5	B3-U0-G5	B3-U0-G5	B3-U0-G5
T4W	4000K/5000K Lumens	5,000	9,771	14,579	19,264	23,869	28,562	33,779	38,274	42,694	47,269
	3000K Lumens	4,426	8,649	12,905	17,052	21,129	25,283	29,901	33,880	37,793	41,843
	BUG Rating	B1-U0-G2	B2-U0-G2	B2-U0-G3	B3-U0-G4	B3-U0-G4	B3-U0-G4	B3-U0-G5	B3-U0-G5	B4-U0-G5	B4-U0-G5
SL2	4000K/5000K Lumens	4,933	9,639	14,383	19,005	23,547	28,178	33,324	37,758	42,118	46,632
	3000K Lumens	4,367	8,532	12,732	16,823	20,844	24,943	29,498	33,423	37,283	41,279
	BUG Rating	B1-U0-G2	B2-U0-G2	B2-U0-G3	B3-U0-G3	B3-U0-G4	B3-U0-G4	B3-U0-G4	B3-U0-G5	B4-U0-G5	B4-U0-G5
SL3	4000K/5000K Lumens	5,036	9,841	14,683	19,401	24,039	28,766	34,019	38,546	42,997	47,605
	3000K Lumens	4,458	8,711	12,997	17,174	21,279	25,464	30,114	34,121	38,061	42,140
	BUG Rating	B1-U0-G2	B1-U0-G2	B2-U0-G3	B2-U0-G3	B3-U0-G4	B3-U0-G4	B3-U0-G5	B3-U0-G5	B3-U0-G5	B3-U0-G5
SL4	4000K/5000K Lumens	4,784	9,350	13,951	18,434	22,840	27,332	32,323	36,624	40,854	45,232
	3000K Lumens	4,235	8,277	12,349	16,318	20,218	24,194	28,612	32,420	36,164	40,039
	BUG Rating	B1-U0-G2	B1-U0-G3	B1-U0-G3	B2-U0-G4	B2-U0-G4	B2-U0-G5	B2-U0-G5	B3-U0-G5	B3-U0-G5	B3-U0-G5
5NQ	4000K/5000K Lumens	5,194	10,150	15,145	20,011	24,794	29,670	35,088	39,757	44,349	49,102
	3000K Lumens	4,598	8,985	13,406	17,714	21,948	26,264	31,060	35,193	39,258	43,465
	BUG Rating	B2-U0-G1	B3-U0-G1	B3-U0-G2	B4-U0-G2	B4-U0-G2	B5-U0-G2	B5-U0-G3	B5-U0-G3	B5-U0-G3	B5-U0-G3
5MQ	4000K/5000K Lumens	5,290	10,337	15,424	20,380	25,250	30,217	35,734	40,489	45,165	50,006
	3000K Lumens	4,683	9,150	13,653	18,040	22,351	26,748	31,632	35,841	39,980	44,265
	BUG Rating	B3-U0-G1	B3-U0-G2	B4-U0-G2	B4-U0-G2	B5-U0-G3	B5-U0-G3	B5-U0-G4	B5-U0-G4	B5-U0-G4	B5-U0-G4
5WQ	4000K/5000K Lumens	5,304	10,365	15,465	20,434	25,318	30,297	35,830	40,597	45,286	50,139
	3000K Lumens	4,695	9,175	13,690	18,088	22,411	26,819	31,717	35,936	40,087	44,383
	BUG Rating	B3-U0-G1	B4-U0-G2	B4-U0-G2	B5-U0-G3	B5-U0-G3	B5-U0-G4	B5-U0-G4	B5-U0-G4	B5-U0-G5	B5-U0-G5
SLL/SLR	4000K/5000K Lumens	4,426	8,648	12,903	17,049	21,124	25,278	29,894	33,872	37,784	41,832
	3000K Lumens	3,918	7,655	11,422	15,092	18,699	22,376	26,462	29,983	33,446	37,030
	BUG Rating	B1-U0-G2	B1-U0-G2	B2-U0-G3	B2-U0-G3	B2-U0-G4	B3-U0-G4	B3-U0-G5	B3-U0-G5	B3-U0-G5	B3-U0-G5
RW	4000K/5000K Lumens	5,147	10,058	15,009	19,830	24,570	29,402	34,771	39,399	43,949	48,658
	3000K Lumens	4,556	8,903	13,286	17,554	21,749	26,027	30,779	34,876	38,904	43,072
	BUG Rating	B2-U0-G1	B3-U0-G1	B3-U0-G2	B4-U0-G2	B4-U0-G2	B4-U0-G2	B5-U0-G3	B5-U0-G3	B5-U0-G3	B5-U0-G4
AFL	4000K/5000K Lumens	5,166	10,095	15,063	19,903	24,659	29,509	34,898	39,542	44,108	48,835
	3000K Lumens	4,573	8,936	13,334	17,618	21,828	26,121	30,892	35,003	39,044	43,229
	BUG Rating	B1-U0-G1	B1-U0-G1	B2-U0-G2	B2-U0-G2	B3-U0-G2	B3-U0-G3	B3-U0-G3	B3-U0-G3	B3-U0-G3	B3-U0-G3

* Nominal data for 70 CRI.

NOMINAL POWER LUMENS (600MA)

Number of Light Squares	1	2	3	4	5	6	7	8	9	10	
Nominal Power (Watts)	34	66	96	129	162	193	226	257	290	323	
Input Current @ 120V (A)	0.30	0.58	0.86	1.16	1.44	1.73	2.03	2.33	2.59	2.89	
Input Current @ 208V (A)	0.17	0.34	0.49	0.65	0.84	0.99	1.14	1.30	1.48	1.63	
Input Current @ 240V (A)	0.15	0.30	0.43	0.56	0.74	0.87	1.00	1.13	1.30	1.43	
Input Current @ 277V (A)	0.14	0.28	0.41	0.52	0.69	0.81	0.93	1.04	1.22	1.33	
Input Current @ 347V (A)	0.11	0.19	0.30	0.39	0.49	0.60	0.69	0.77	0.90	0.99	
Input Current @ 480V (A)	0.08	0.15	0.24	0.30	0.38	0.48	0.53	0.59	0.71	0.77	
Optics											
T2	4000K/5000K Lumens	4,029	7,874	11,749	15,525	19,235	23,019	27,222	30,844	34,406	38,093
	3000K Lumens	3,566	6,970	10,400	13,743	17,027	20,376	24,097	27,303	30,456	33,720
	BUG Rating	B1-U0-G1	B1-U0-G2	B2-U0-G2	B2-U0-G2	B3-U0-G3	B3-U0-G3	B3-U0-G4	B3-U0-G4	B3-U0-G4	B3-U0-G4
T2R	4000K/5000K Lumens	4,278	8,360	12,474	16,482	20,421	24,437	28,900	32,745	36,527	40,441
	3000K Lumens	3,787	7,400	11,042	14,590	18,077	21,632	25,582	28,986	32,334	35,798
	BUG Rating	B1-U0-G1	B1-U0-G2	B2-U0-G2	B2-U0-G2	B2-U0-G3	B3-U0-G3	B3-U0-G3	B3-U0-G4	B3-U0-G4	B3-U0-G4
T3	4000K/5000K Lumens	4,107	8,026	11,976	15,824	19,605	23,461	27,746	31,438	35,068	38,827
	3000K Lumens	3,636	7,105	10,601	14,007	17,354	20,768	24,561	27,829	31,042	34,370
	BUG Rating	B1-U0-G1	B1-U0-G2	B2-U0-G2	B2-U0-G3	B3-U0-G3	B3-U0-G4	B3-U0-G4	B3-U0-G4	B3-U0-G5	B3-U0-G5
T3R	4000K/5000K Lumens	4,198	8,205	12,242	16,175	20,041	23,982	28,363	32,137	35,848	39,689
	3000K Lumens	3,716	7,263	10,837	14,318	17,740	21,229	25,107	28,448	31,733	35,133
	BUG Rating	B1-U0-G1	B1-U0-G2	B2-U0-G2	B2-U0-G3	B2-U0-G3	B3-U0-G4	B3-U0-G4	B3-U0-G4	B3-U0-G5	B3-U0-G5
T4FT	4000K/5000K Lumens	4,131	8,072	12,045	15,915	19,719	23,597	27,907	31,620	35,272	39,052
	3000K Lumens	3,657	7,145	10,662	14,088	17,455	20,888	24,703	27,990	31,223	34,569
	BUG Rating	B1-U0-G1	B1-U0-G2	B2-U0-G2	B2-U0-G3	B2-U0-G4	B3-U0-G4	B3-U0-G4	B3-U0-G5	B3-U0-G5	B3-U0-G5
T4W	4000K/5000K Lumens	4,077	7,968	11,889	15,710	19,465	23,292	27,546	31,212	34,816	38,547
	3000K Lumens	3,609	7,053	10,524	13,906	17,230	20,618	24,384	27,629	30,819	34,122
	BUG Rating	B1-U0-G1	B1-U0-G2	B2-U0-G2	B2-U0-G3	B3-U0-G4	B3-U0-G4	B3-U0-G4	B3-U0-G5	B3-U0-G5	B3-U0-G5
SL2	4000K/5000K Lumens	4,022	7,861	11,729	15,498	19,202	22,979	27,175	30,791	34,347	38,028
	3000K Lumens	3,560	6,959	10,383	13,719	16,998	20,341	24,055	27,256	30,404	33,662
	BUG Rating	B1-U0-G1	B1-U0-G2	B2-U0-G3	B2-U0-G3	B3-U0-G3	B3-U0-G4	B3-U0-G4	B3-U0-G4	B3-U0-G5	B3-U0-G5
SL3	4000K/5000K Lumens	4,106	8,025	11,974	15,821	19,603	23,458	27,742	31,433	35,064	38,821
	3000K Lumens	3,635	7,104	10,599	14,005	17,353	20,765	24,557	27,824	31,039	34,364
	BUG Rating	B1-U0-G1	B1-U0-G2	B2-U0-G3	B2-U0-G3	B2-U0-G3	B3-U0-G4	B3-U0-G4	B3-U0-G4	B3-U0-G5	B3-U0-G5
SL4	4000K/5000K Lumens	3,902	7,624	11,377	15,033	18,626	22,289	26,359	29,867	33,316	36,886
	3000K Lumens	3,454	6,749	10,071	13,307	16,488	19,730	23,333	26,438	29,491	32,651
	BUG Rating	B1-U0-G2	B1-U0-G2	B1-U0-G3	B1-U0-G3	B2-U0-G4	B2-U0-G4	B2-U0-G4	B2-U0-G5	B3-U0-G5	B3-U0-G5
5NQ	4000K/5000K Lumens	4,236	8,277	12,351	16,319	20,219	24,196	28,614	32,422	36,166	40,042
	3000K Lumens	3,750	7,327	10,933	14,446	17,898	21,418	25,329	28,700	32,014	35,445
	BUG Rating	B2-U0-G1	B3-U0-G1	B3-U0-G2	B3-U0-G2	B4-U0-G2	B4-U0-G2	B4-U0-G2	B5-U0-G2	B5-U0-G3	B5-U0-G3
5MQ	4000K/5000K Lumens	4,314	8,429	12,578	16,619	20,591	24,641	29,141	33,019	36,832	40,779
	3000K Lumens	3,819	7,461	11,134	14,711	18,227	21,812	25,796	29,228	32,604	36,098
	BUG Rating	B3-U0-G1	B3-U0-G2	B4-U0-G2	B4-U0-G2	B4-U0-G2	B5-U0-G3	B5-U0-G3	B5-U0-G4	B5-U0-G4	B5-U0-G4
5WQ	4000K/5000K Lumens	4,325	8,452	12,611	16,664	20,646	24,707	29,219	33,106	36,930	40,888
	3000K Lumens	3,828	7,482	11,163	14,751	18,276	21,871	25,865	29,305	32,690	36,194
	BUG Rating	B3-U0-G1	B3-U0-G2	B4-U0-G2	B4-U0-G2	B5-U0-G3	B5-U0-G3	B5-U0-G4	B5-U0-G4	B5-U0-G4	B5-U0-G4
SLL/SLR	4000K/5000K Lumens	3,609	7,052	10,522	13,903	17,226	20,613	24,378	27,622	30,812	34,114
	3000K Lumens	3,195	6,242	9,314	12,307	15,248	18,247	21,579	24,451	27,275	30,198
	BUG Rating	B1-U0-G1	B1-U0-G2	B1-U0-G3	B2-U0-G3	B2-U0-G3	B2-U0-G4	B3-U0-G4	B3-U0-G4	B3-U0-G5	B3-U0-G5
RW	4000K/5000K Lumens	4,197	8,202	12,239	16,171	20,036	23,977	28,356	32,129	35,839	39,680
	3000K Lumens	3,715	7,260	10,834	14,315	17,736	21,224	25,101	28,441	31,725	35,125
	BUG Rating	B2-U0-G1	B3-U0-G1	B3-U0-G2	B4-U0-G2	B4-U0-G2	B4-U0-G2	B4-U0-G2	B5-U0-G3	B5-U0-G3	B5-U0-G3
AFL	4000K/5000K Lumens	4,213	8,232	12,284	16,230	20,109	24,064	28,459	32,246	35,969	39,824
	3000K Lumens	3,729	7,287	10,874	14,367	17,800	21,301	25,192	28,544	31,840	35,252
	BUG Rating	B1-U0-G1	B1-U0-G1	B2-U0-G2	B2-U0-G2	B2-U0-G2	B3-U0-G2	B3-U0-G3	B3-U0-G3	B3-U0-G3	B3-U0-G3

* Nominal data for 70 CRI.

CONTROL OPTIONS

0-10V (DIM)

This fixture is offered standard with 0-10V dimming driver(s). The DIM option provides 0-10V dimming wire leads for use with a lighting control panel or other control method.

Photocontrol (P, R and PER7)

Optional button-type photocontrol (P) and photocontrol receptacles (R and PER7) provide a flexible solution to enable "dusk-to-dawn" lighting by sensing light levels. Advanced control systems compatible with NEMA 7-pin standards can be utilized with the PER7 receptacle.

After Hours Dim (AHD)

This feature allows photocontrol-enabled luminaires to achieve additional energy savings by dimming during scheduled portions of the night. The dimming profile will automatically take effect after a "dusk-to-dawn" period has been calculated from the photocontrol input. Specify the desired dimming profile for a simple, factory-shipped dimming solution requiring no external control wiring. Reference the After Hours Dim supplemental guide for additional information.

Dimming Occupancy Sensor (MS/DIM-LXX, MS/X-LXX and MS-LXX)

These sensors are factory installed in the luminaire housing. When the MS/DIM-LXX sensor option is selected, the occupancy sensor is connected to a dimming driver and the entire luminaire dims when there is no activity detected. When activity is detected, the luminaire returns to full light output. The MS/DIM sensor is factory preset to dim down to approximately 50 percent power with a time delay of five minutes. The MS-LXX sensor is factory preset to turn the luminaire off after five minutes of no activity. The MS/X-LXX is also preset for five minutes and only controls the specified number of light engines to maintain steady output from the remaining light engines.

These occupancy sensors includes an integral photocell that can be activated with the FSIR-100 accessory for "dusk-to-dawn" control or daylight harvesting - the factory preset is OFF. The FSIR-100 is a wireless tool utilized for changing the dimming level, time delay, sensitivity and other parameters. A variety of sensor lens are available to optimize the coverage pattern for mounting heights from 8'-40'.

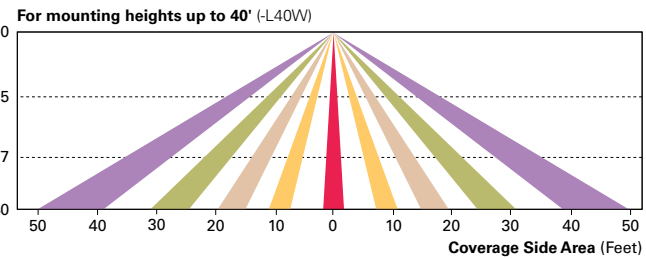
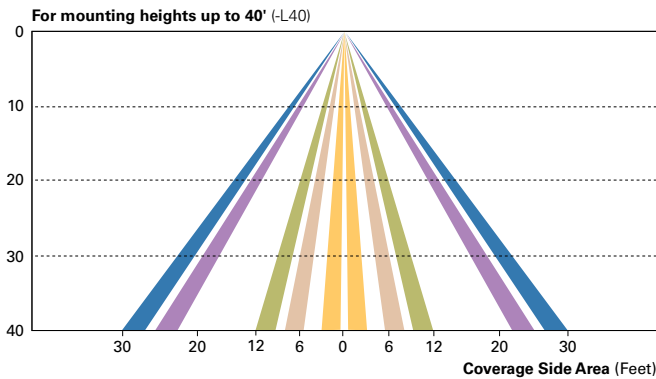
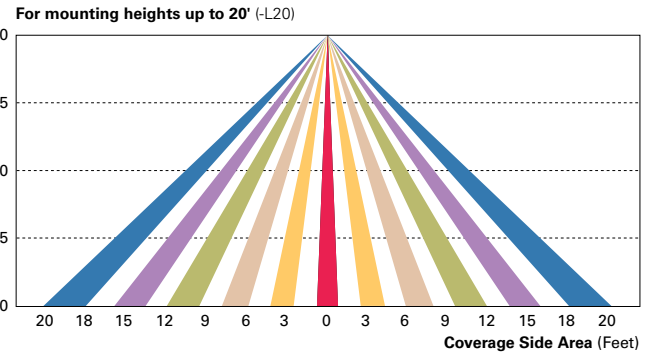
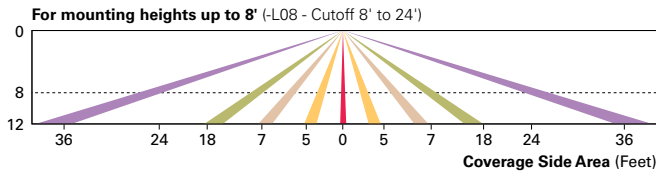

LumaWatt Pro Wireless Control and Monitoring System (LWR-LW and LWR-LN)

The Eaton's LumaWatt Pro powered by Enlighted is a connected lighting solution that combines a broad selection of energy-efficient LED luminaires with a powerful integrated wireless sensor system. The sensor controls the lighting system in compliance with the latest energy codes and collects valuable data about building performance and use. Software applications turn the granular data into information through energy dashboards and specialized apps that make it simple and help optimize the use of building resources, beyond lighting.

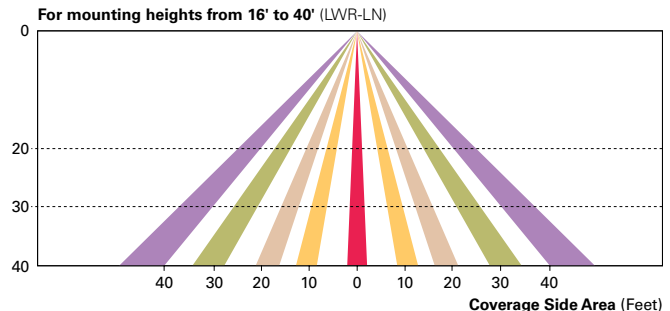
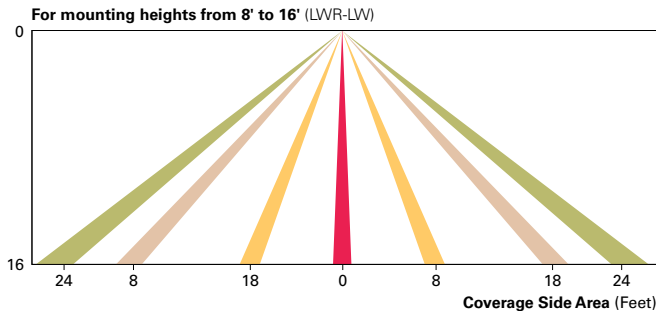

WaveLinX Wireless Outdoor Lighting Control Module (WOLC-7P-10A)

The 7-pin wireless outdoor lighting control module enables WaveLinX to control outdoor area, site and flood lighting. WaveLinX controls outdoor lighting using schedules to provide ON, OFF and dimming controls based on astronomic or time schedules based on a 7 day week.

ORDERING INFORMATION

Sample Number: GLEON-AF-04-LED-E1-T3-GM-QM

Product Family ^{1,2}	Light Engine	Number of Light Squares ³	Lamp Type	Voltage	Distribution	Color	Mounting
GLEON=Galleon	AF=1A Drive Current	01=1 02=2 03=3 04=4 05=5 ⁴ 06=6 07=7 ⁵ 08=8 ⁵ 09=9 ⁶ 10=10 ⁶	LED=Solid State Light Emitting Diodes	E1=120-277V 347=347V ⁷ 480=480V ^{7,8}	T2=Type II T2R=Type II Roadway T3=Type III T3R=Type III Roadway T4FT=Type IV Forward Throw T4W=Type IV Wide 5NQ=Type V Narrow 5MQ=Type V Square Medium 5WQ=Type V Square Wide SL2=Type II w/Spill Control SL3=Type III w/Spill Control SL4=Type IV w/Spill Control SLL=90° Spill Light Eliminator Left SLR=90° Spill Light Eliminator Right RW=Rectangular Wide Type I AFL=Automotive Frontline	AP=Grey BZ=Bronze BK=Black DP=Dark Platinum GM=Graphite Metallic WH=White	[Blank]=Arm for Round or Square Pole EA=Extended Arm ⁹ MA=Mast Arm Adapter ¹⁰ WM=Wall Mount QM=Quick Mount Arm (Standard Length) ¹¹ QMEA=Quick Mount Arm (Extended Length) ¹²
Options (Add as Suffix)					Accessories (Order Separately)		
<p>7030=70 CRI 3000K¹³</p> <p>8030=80 CRI 3000K¹⁴</p> <p>7050=70 CRI 5000K¹³</p> <p>7060=70 CRI 6000K¹³</p> <p>600=Drive Current Factory Set to Nominal 600mA¹⁵</p> <p>800=Drive Current Factory Set to Nominal 800mA¹⁵</p> <p>1200=Drive Current Factory Set to Nominal 1200mA^{15,16}</p> <p>F=Single Fuse (120, 277 or 347V. Must Specify Voltage)</p> <p>FF=Double Fuse (208, 240 or 480V. Must Specify Voltage)</p> <p>2L=Two Circuits^{17,18}</p> <p>DIM=External 0-10V Dimming Leads^{19,20}</p> <p>P=Button Type Photocontrol (120, 208, 240 or 277V. Must Specify Voltage)²¹</p> <p>PER7=NEMA 7-PIN Twistlock Photocontrol Receptacle²¹</p> <p>R=NEMA Twistlock Photocontrol Receptacle²¹</p> <p>AHD145=After Hours Dim, 5 Hours²²</p> <p>AHD245=After Hours Dim, 6 Hours²²</p> <p>AHD255=After Hours Dim, 7 Hours²²</p> <p>AHD355=After Hours Dim, 8 Hours²²</p> <p>HA=50°C High Ambient²³</p> <p>MS/DIM-L08=Motion Sensor for Dimming Operation, Maximum 8' Mounting Height^{24,25}</p> <p>MS/DIM-L20=Motion Sensor for Dimming Operation, 9' - 20' Mounting Height^{24,26}</p> <p>MS/DIM-L40=Motion Sensor for Dimming Operation, 21' - 40' Mounting Height^{24,27}</p> <p>MS/DIM-L40W=Motion Sensor for Dimming Operation, 21' - 40' Mounting Height (Wide Range)^{24,28}</p> <p>MS/X-L08=Bi-Level Motion Sensor, Maximum 8' Mounting Height^{24,25,29}</p> <p>MS/X-L20=Bi-Level Motion Sensor, 9' - 20' Mounting Height^{24,26,29}</p> <p>MS/X-L40=Bi-Level Motion Sensor, 21' - 40' Mounting Height^{22,27,29}</p> <p>MS/X-L40W=Bi-Level Motion Sensor, 21' - 40' Mounting Height (Wide Range)^{24,28,29}</p> <p>MS-L08=Motion Sensor for ON/OFF Operation, Maximum 8' Mounting Height^{24,25}</p> <p>MS-L20=Motion Sensor for ON/OFF Operation, 9' - 20' Mounting Height^{24,26}</p> <p>MS-L40=Motion Sensor for ON/OFF Operation, 21' - 40' Mounting Height^{24,27}</p> <p>MS-L40W=Motion Sensor for ON/OFF Operation, 21' - 40' Mounting Height (Wide Range)^{24,28}</p> <p>LWR-LW=LumaWatt Pro Wireless Sensor, Wide Lens for 8' - 16' Mounting Height³⁰</p> <p>LWR-LN=LumaWatt Pro Wireless Sensor, Narrow Lens for 16' - 40' Mounting Height³⁰</p> <p>L90=Optics Rotated 90° Left</p> <p>R90=Optics Rotated 90° Right</p> <p>MIT=Factory Installed Mesh Top</p> <p>TH=Tool-less Door Hardware</p> <p>LCF=Light Square Trim Plate Painted to Match Housing³¹</p> <p>HSS=Factory Installed House Side Shield³²</p> <p>CE=CE Marking³³</p>					<p>OA/RA1016=NEMA Photocontrol Multi-Tap - 105-285V</p> <p>OA/RA1027=NEMA Photocontrol - 480V</p> <p>OA/RA1201=NEMA Photocontrol - 347V</p> <p>OA/RA1013=Photocontrol Shorting Cap</p> <p>OA/RA1014=120V Photocontrol</p> <p>MA1252=10kV Surge Module Replacement</p> <p>MA1036-XX=Single Tenon Adapter for 2-3/8" O.D. Tenon</p> <p>MA1037-XX=2 @ 180° Tenon Adapter for 2-3/8" O.D. Tenon</p> <p>MA1197-XX=3 @ 120° Tenon Adapter for 2-3/8" O.D. Tenon</p> <p>MA1188-XX=4 @ 90° Tenon Adapter for 2-3/8" O.D. Tenon</p> <p>MA1189-XX=2 @ 90° Tenon Adapter for 2-3/8" O.D. Tenon</p> <p>MA1190-XX=3 @ 90° Tenon Adapter for 3-1/2" O.D. Tenon</p> <p>MA1191-XX=2 @ 120° Tenon Adapter for 2-3/8" O.D. Tenon</p> <p>MA1038-XX=Single Tenon Adapter for 3-1/2" O.D. Tenon</p> <p>MA1039-XX=2 @ 180° Tenon Adapter for 3-1/2" O.D. Tenon</p> <p>MA1192-XX=3 @ 120° Tenon Adapter for 3-1/2" O.D. Tenon</p> <p>MA1193-XX=4 @ 90° Tenon Adapter for 3-1/2" O.D. Tenon</p> <p>MA1194-XX=2 @ 90° Tenon Adapter for 3-1/2" O.D. Tenon</p> <p>MA1195-XX=3 @ 90° Tenon Adapter for 3-1/2" O.D. Tenon</p> <p>FSIR-100=Wireless Configuration Tool for Occupancy Sensor³⁴</p> <p>GLEON-MT1=Field Installed Mesh Top for 1-4 Light Squares</p> <p>GLEON-MT2=Field Installed Mesh Top for 5-6 Light Squares</p> <p>GLEON-MT3=Field Installed Mesh Top for 7-8 Light Squares</p> <p>GLEON-MT4=Field Installed Mesh Top for 9-10 Light Squares</p> <p>GLEON-QM-XX=Quick Mount Arm Kit¹⁰</p> <p>GLEON-QMEA-XX=Quick Mount Extended Arm Kit¹¹</p> <p>LS/HSS=Field Installed House Side Shield^{32,34}</p> <p>WOLC-7P-10A=WaveLinX Outdoor Control Module (7-pin)³⁵</p>		

NOTES:

- Customer is responsible for engineering analysis to confirm pole and fixture compatibility for all applications. Refer to our white paper WP513001EN for additional support information.
- DesignLights Consortium® Qualified. Refer to www.designlights.org Qualified Products List under Family Models for details.
- Standard 4000K CCT and minimum 70 CRI.
- Not compatible with MS/4-LXX or MS/1-LXX sensors.
- Not compatible with extended quick mount arm (QMEA).
- Not compatible with standard quick mount arm (QM) or extended quick mount arm (QMEA).
- Requires the use of an internal step down transformer when combined with sensor options. Not available with sensor at 1200mA. Not available in combination with the HA high ambient and sensor options at 1A.
- Only for use with 480V Wye systems. Per NEC, not for use with ungrounded systems, impedance grounded systems or corner grounded systems (commonly known as Three Phase Three Wire Delta, Three Phase High Leg Delta and Three Phase Corner Grounded Delta systems).
- May be required when two or more luminaires are oriented on a 90° or 120° drilling pattern. Refer to arm mounting requirement table.
- Factory installed.
- Maximum 8 light squares.
- Maximum 6 light squares.
- Extended lead times apply. Use dedicated IES files for 3000K, 5000K and 6000K when performing layouts. These files are published on the Galleon luminaire product page on the website.
- Extended lead times apply. Use dedicated IES files for 3000K, 5000K and 6000K when performing layouts. These files are published on the Galleon luminaire product page on the website.
- 1 Amp standard. Use dedicated IES files for 600mA, 800mA and 1200mA when performing layouts. These files are published on the Galleon luminaire product page on the website.
- Not available with HA option.
- 2L is not available with MS, MS/X or MS/DIM at 347V or 480V. 2L in AF-02 through AF-04 requires a larger housing, normally used for AF-05 or AF-06. Extended arm option may be required when mounting two or more fixtures per pole at 90° or 120°. Refer to arm mounting requirement table.
- Not available with LumaWatt Pro wireless sensors.
- Cannot be used with other control options.
- Low voltage control lead brought out 18" outside fixture.
- Not available if any "MS" sensor is selected. Motion sensor has an integral photocell.
- Requires the use of P photocontrol or the PER7 or R photocontrol receptacle with photocontrol accessory. See After Hours Dim supplemental guide for additional information.
- 50°C lumen maintenance data applies to 600mA, 800mA and 1A drive currents.
- The FSIR-100 configuration tool is required to adjust parameters including high and low modes, sensitivity, time delay, cutoff and more. Consult your lighting representative at Eaton for more information.
- Approximately 22' detection diameter at 8' mounting height.
- Approximately 40' detection diameter at 20' mounting height.
- Approximately 60' detection diameter at 40' mounting height.
- Approximately 100' detection diameter at 40' mounting height.
- Replace X with number of Light Squares operating in low output mode.
- LumaWatt Pro wireless sensors are factory installed only requiring network components LWP-EM-1, LWP-GW-1 and LWP-PoE8 in appropriate quantities. See www.eaton.com/lighting for LumaWatt Pro application information.
- Not available with house side shield (HSS).
- Only for use with SL2, SL3, SL4 and AFL distributions. The Light Square trim plate is painted black when the HSS option is selected.
- CE is not available with the LWR, MS, MS/X, MS/DIM, P, R or PER7 options. Available in 120-277V only.
- One required for each Light Square.
- Requires 7-pin NEMA twistlock photocontrol receptacle.